

Lens Mounting Ring A-Series

Part Number: LMRA-40

Mechanical Drawing:

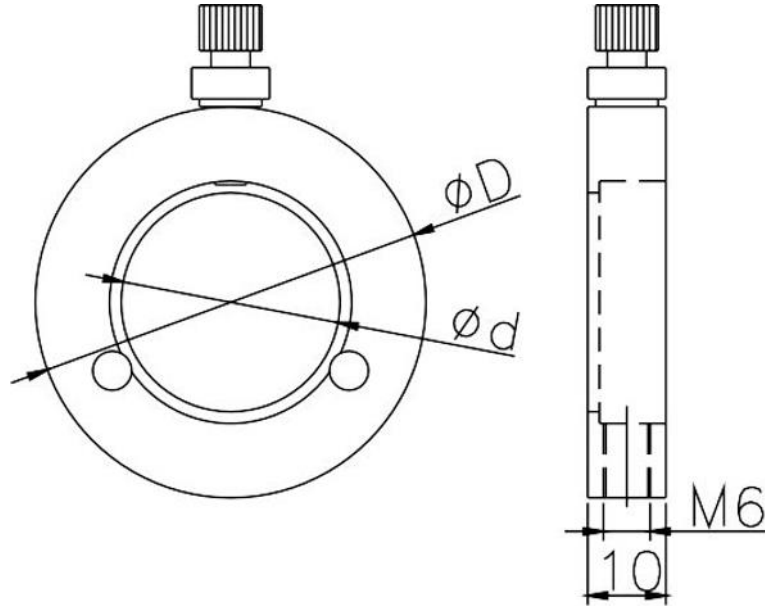

Technical Specifications:

Lens Diameter (mm)	$\Phi 40$
Outer Diameter, ΦD (mm)	$\Phi 60$
Aperture, Φd (mm)	$\Phi 38$

NOTE: PROPRIETARY AND CONFIDENTIAL THE INFORMATION CONTAINED IN THIS DRAWING IS THE SOLE PROPERTY OF WAVELENGTH OPTO-ELECTRONIC(S) PTE LTD. ANY REPRODUCTION INPART OR AS A WHOLE WITHOUT THE WRITTEN PERMISSION OF WAVELENGTH OPTO-ELECTRONIC(S) PTE LTD. IS PROHIBITED.