

Lens Mounting Ring B-Series

Part Number: LMRB-30

Mechanical Drawing:

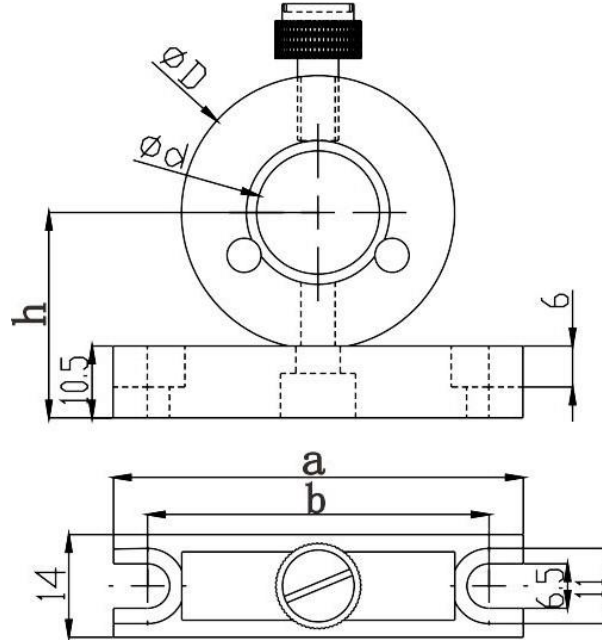

Technical Specifications:

Lens Diameter (mm)	$\phi 30$
Outer Diameter, ϕD (mm)	$\phi 50$
Aperture, ϕd (mm)	$\phi 28$
Height from base to centre of aperture, h (mm)	32
Length, a (mm)	60
Installation Distance, b (mm)	50

NOTE: PROPRIETARY AND CONFIDENTIAL THE INFORMATION CONTAINED IN THIS DRAWING IS THE SOLE PROPERTY OF WAVELENGTH OPTO-ELECTRONIC(S) PTE LTD. ANY REPRODUCTION INPART OR AS A WHOLE WITHOUT THE WRITTEN PERMISSION OF WAVELENGTH OPTO-ELECTRONIC(S) PTE LTD. IS PROHIBITED.