

Lens Mount (2-Axis) F-Series

Part Number: LM-2F-75

Mechanical Drawing:

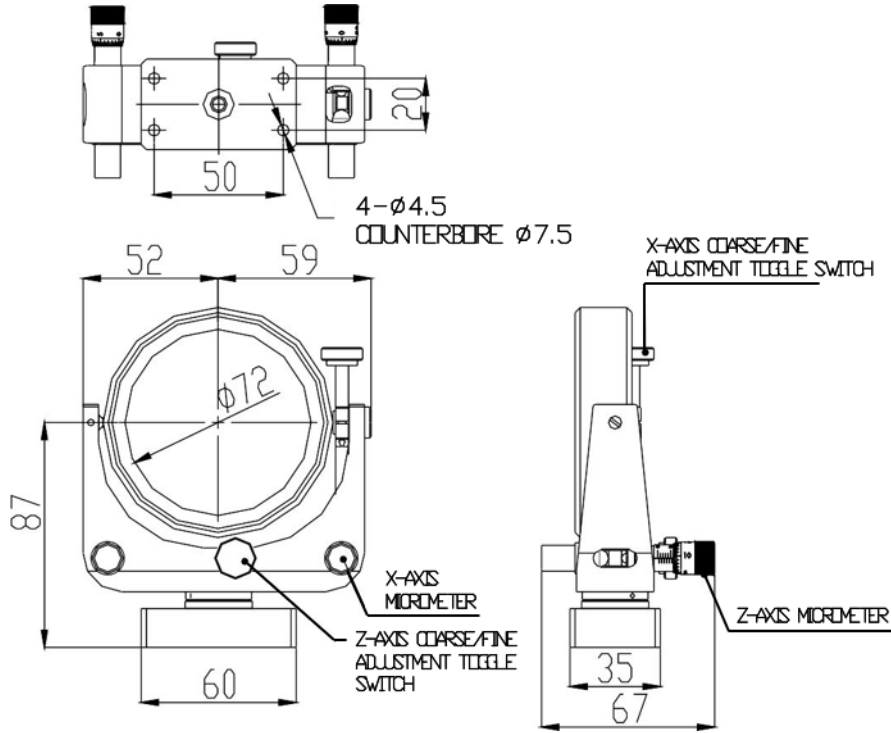

Technical Specifications:

Direction			X and Z-Axis
Dimensions of Lens (mm)			$\phi$ 75
Adjustment Range	Coarse		360°
	Fine	X-Axis	$\pm$ 3.5°
		Z-Axis	$\pm$ 3.5°
Resolution			0.005°
Weight (kg)			0.53

**NOTE: PROPRIETARY AND CONFIDENTIAL THE INFORMATION CONTAINED IN THIS DRAWING IS THE SOLE PROPERTY OF WAVELENGTH OPTO-ELECTRONIC(S) PTE LTD. ANY REPRODUCTION INPART OR AS A WHOLE WITHOUT THE WRITTEN PERMISSION OF WAVELENGTH OPTO-ELECTRONIC(S) PTE LTD. IS PROHIBITED.**