

Lens Mount (2-Axis) D-Series

Part Number: LM-2D-50-30

Mechanical Drawing:

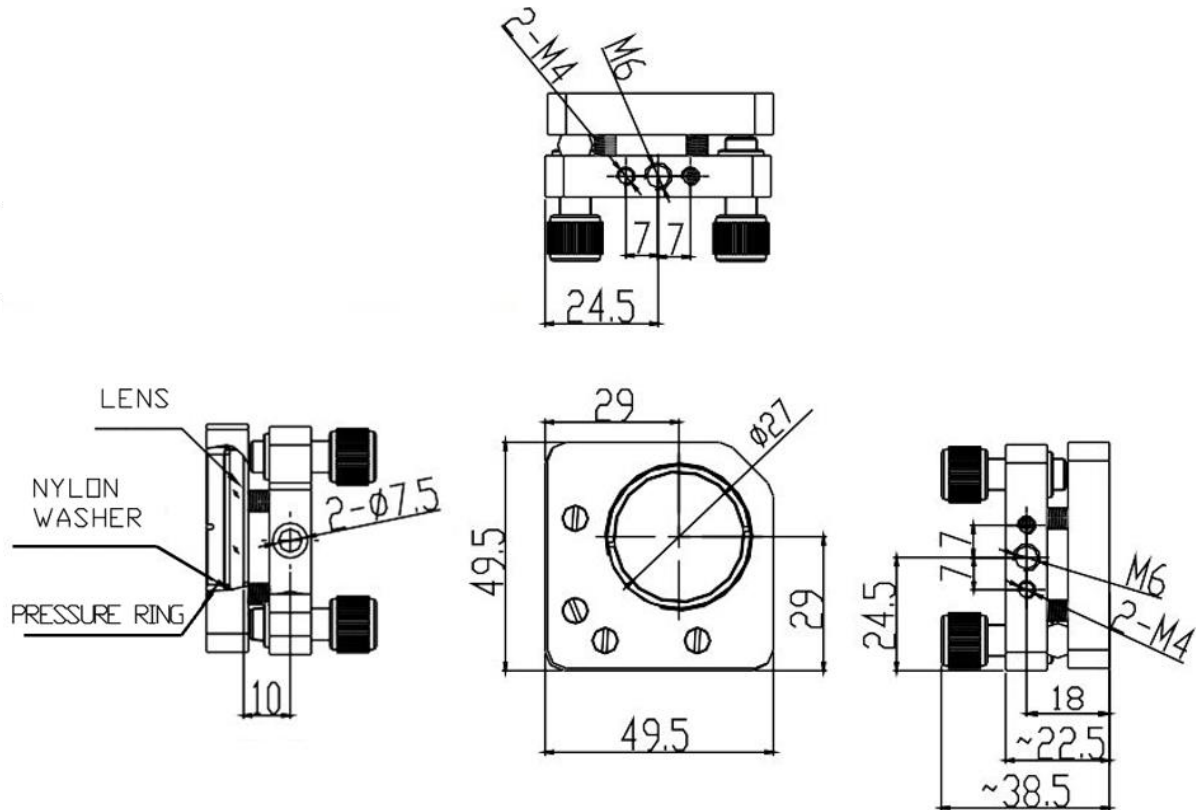

Technical Specifications:

Direction	X and Z-Axis
Dimensions (mm)	50x50
Dimensions of Lens (mm)	$\Phi 30 \times 2 \sim 5$
Adjustment Range	$\pm 2.5^\circ$
Resolution	0.002°
Aperture (mm)	$\Phi 27$

NOTE: PROPRIETARY AND CONFIDENTIAL THE INFORMATION CONTAINED IN THIS DRAWING IS THE SOLE PROPERTY OF WAVELENGTH OPTO-ELECTRONIC(S) PTE LTD. ANY REPRODUCTION INPART OR AS A WHOLE WITHOUT THE WRITTEN PERMISSION OF WAVELENGTH OPTO-ELECTRONIC(S) PTE LTD. IS PROHIBITED.