

Lens Mount (2-Axis) B-Series

Part Number: LM-2B-40-10

Mechanical Drawing:

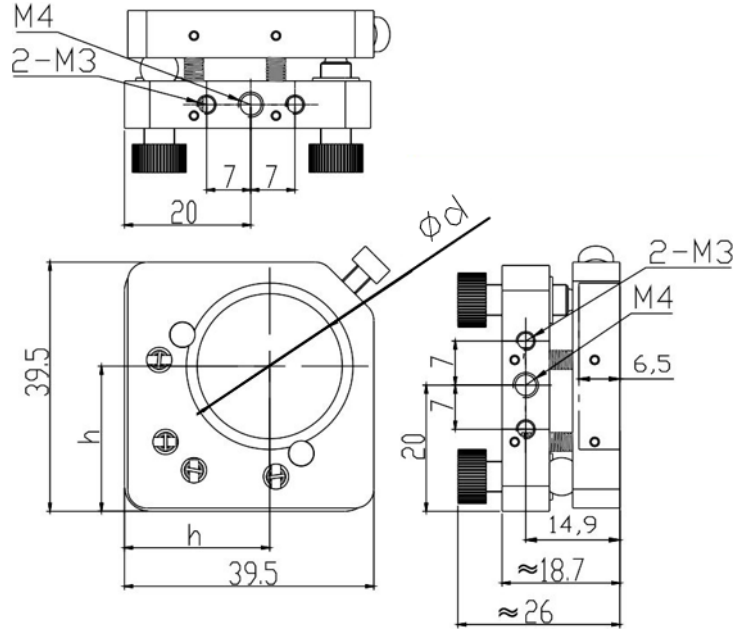

Technical Specifications:

Direction	X and Z-Axis
Dimensions (mm)	40x40
Dimensions of Lens (mm)	Φ10x2~8
Adjustment Range	±3°
Resolution	0.003°
Aperture, Φd (mm)	Φ8
Height from base to centre, h (mm)	20

NOTE: PROPRIETARY AND CONFIDENTIAL THE INFORMATION CONTAINED IN THIS DRAWING IS THE SOLE PROPERTY OF WAVELENGTH OPTO-ELECTRONIC(S) PTE LTD. ANY REPRODUCTION INPART OR AS A WHOLE WITHOUT THE WRITTEN PERMISSION OF WAVELENGTH OPTO-ELECTRONIC(S) PTE LTD. IS PROHIBITED.