

Iris D-Series

Part Number: IRD-24

Mechanical Drawing:

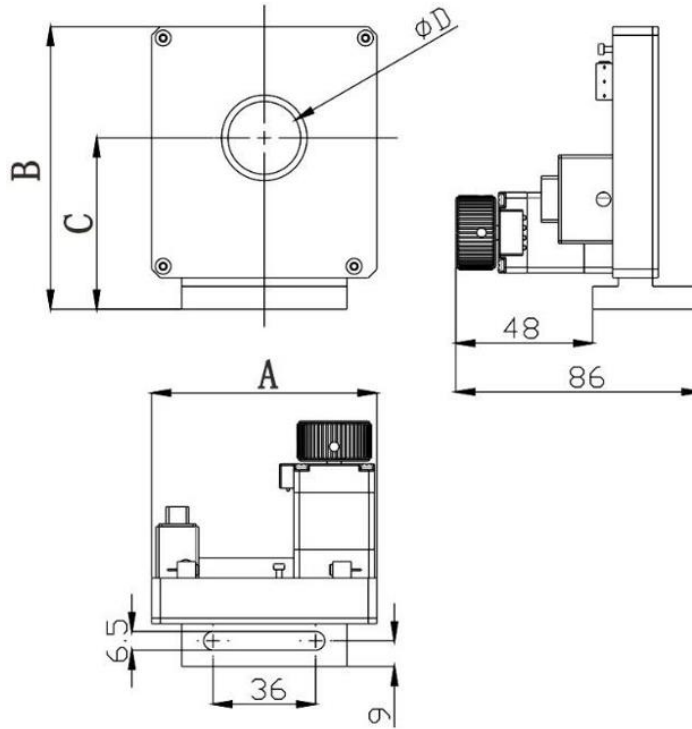

Technical Specifications:

Aperture, $\Phi D$ (mm)	$\Phi 1.5 - \Phi 24$
Width, A (mm)	79
Height, B (mm)	99
Distance from base to centre, C (mm)	60
Weight (kg)	0.64

**NOTE: PROPRIETARY AND CONFIDENTIAL THE INFORMATION CONTAINED IN THIS DRAWING IS THE SOLE PROPERTY OF WAVELENGTH OPTO-ELECTRONIC(S) PTE LTD. ANY REPRODUCTION INPART OR AS A WHOLE WITHOUT THE WRITTEN PERMISSION OF WAVELENGTH OPTO-ELECTRONIC(S) PTE LTD. IS PROHIBITED.**