

Iris C-Series

Part Number: IRC-12-37

Mechanical Drawing:

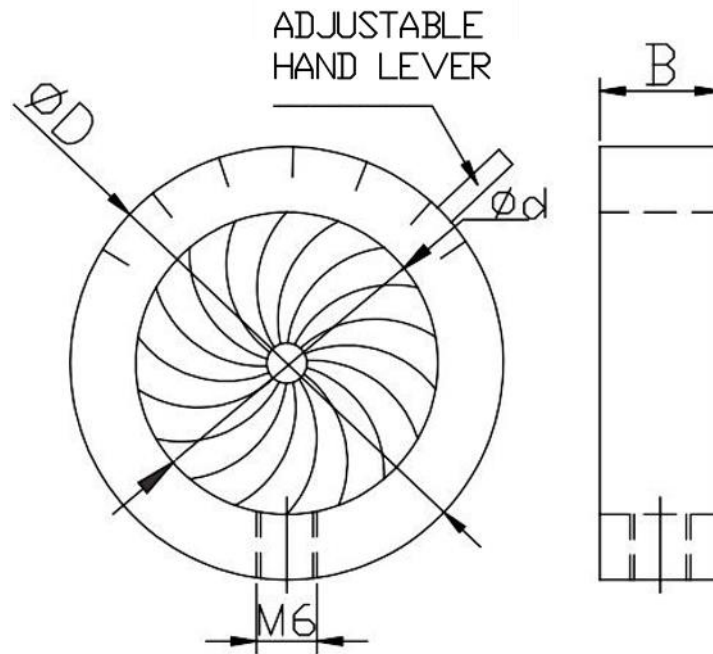

Technical Specifications:

Aperture, Φd (mm)	$\Phi 1 - \Phi 12$
Outer Diameter, ΦD (mm)	$\Phi 37$
Width, B (mm)	9
Thread Size	M6

NOTE: PROPRIETARY AND CONFIDENTIAL THE INFORMATION CONTAINED IN THIS DRAWING IS THE SOLE PROPERTY OF WAVELENGTH OPTO-ELECTRONIC(S) PTE LTD. ANY REPRODUCTION INPART OR AS A WHOLE WITHOUT THE WRITTEN PERMISSION OF WAVELENGTH OPTO-ELECTRONIC(S) PTE LTD. IS PROHIBITED.