

Rotational Post Holder A-Series

Part Number: RPHA-85

Mechanical Drawing:

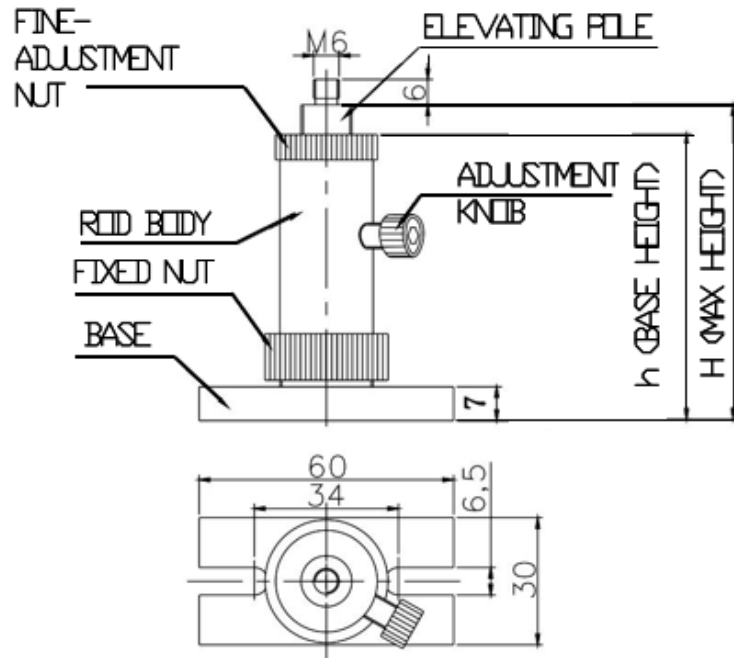

Technical Specifications:

Base Height, h (mm)	85
Max Height, H (mm)	110
Weight (kg)	0.15

**NOTE: PROPRIETARY AND CONFIDENTIAL THE INFORMATION CONTAINED IN THIS DRAWING IS THE SOLE PROPERTY OF WAVELENGTH OPTO-ELECTRONIC(S) PTE LTD. ANY REPRODUCTION INPART OR AS A WHOLE WITHOUT THE WRITTEN PERMISSION OF WAVELENGTH OPTO-ELECTRONIC(S) PTE LTD. IS PROHIBITED.**