

Rotational Post Holder C-Series

Part Number: RPHC-35

Mechanical Drawing:

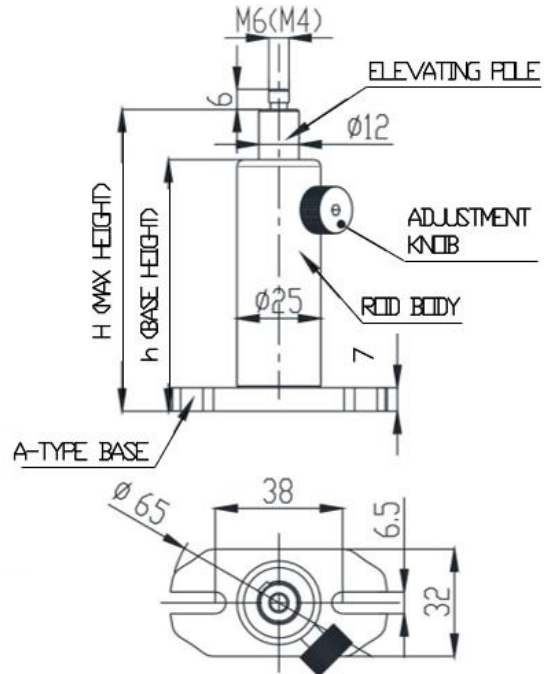

Technical Specifications:

Base Height, h (mm)	35
Max Height, H (mm)	50
Weight (kg)	0.1

NOTE: PROPRIETARY AND CONFIDENTIAL THE INFORMATION CONTAINED IN THIS DRAWING IS THE SOLE PROPERTY OF WAVELENGTH OPTO-ELECTRONIC(S) PTE LTD. ANY REPRODUCTION INPART OR AS A WHOLE WITHOUT THE WRITTEN PERMISSION OF WAVELENGTH OPTO-ELECTRONIC(S) PTE LTD. IS PROHIBITED.