

Rod Clamp with Rod B-Series

Part Number: RCRB-C-76-400

Mechanical Drawing:

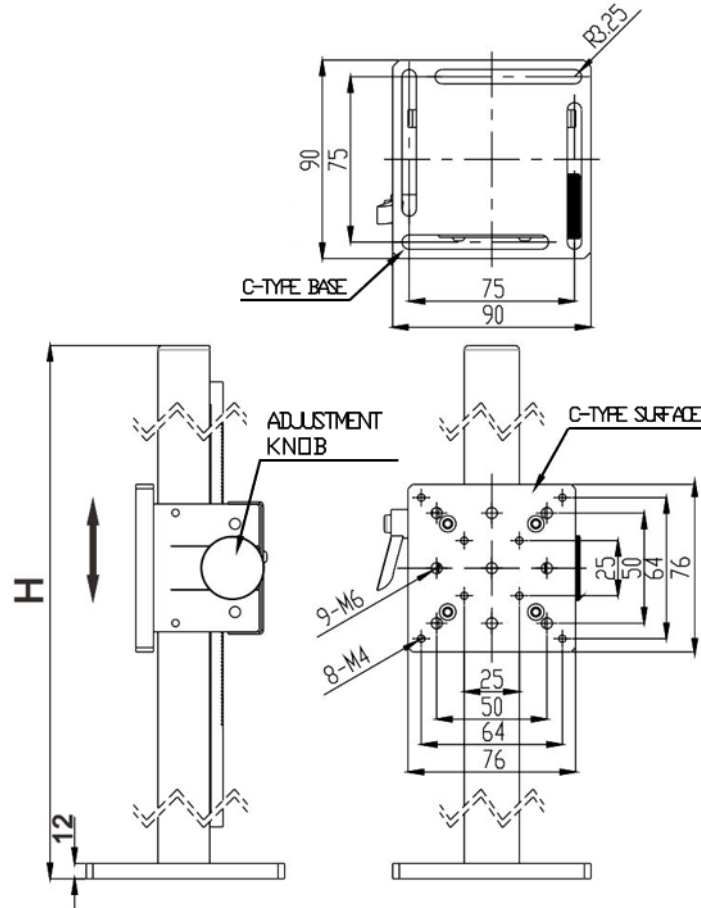

Technical Specifications:

Length (mm)	76 x 76
Height, H (mm)	400
Maximum Displacement (mm)	310
Weight (kg)	1.18

**NOTE: PROPRIETARY AND CONFIDENTIAL THE INFORMATION CONTAINED IN THIS DRAWING IS THE SOLE PROPERTY OF WAVELENGTH OPTO-ELECTRONIC(S) PTE LTD. ANY REPRODUCTION INPART OR AS A WHOLE WITHOUT THE WRITTEN PERMISSION OF WAVELENGTH OPTO-ELECTRONIC(S) PTE LTD. IS PROHIBITED.**