

Rod Clamp with Rod B-Series

Part Number: RCRB-B-58-300

Mechanical Drawing:

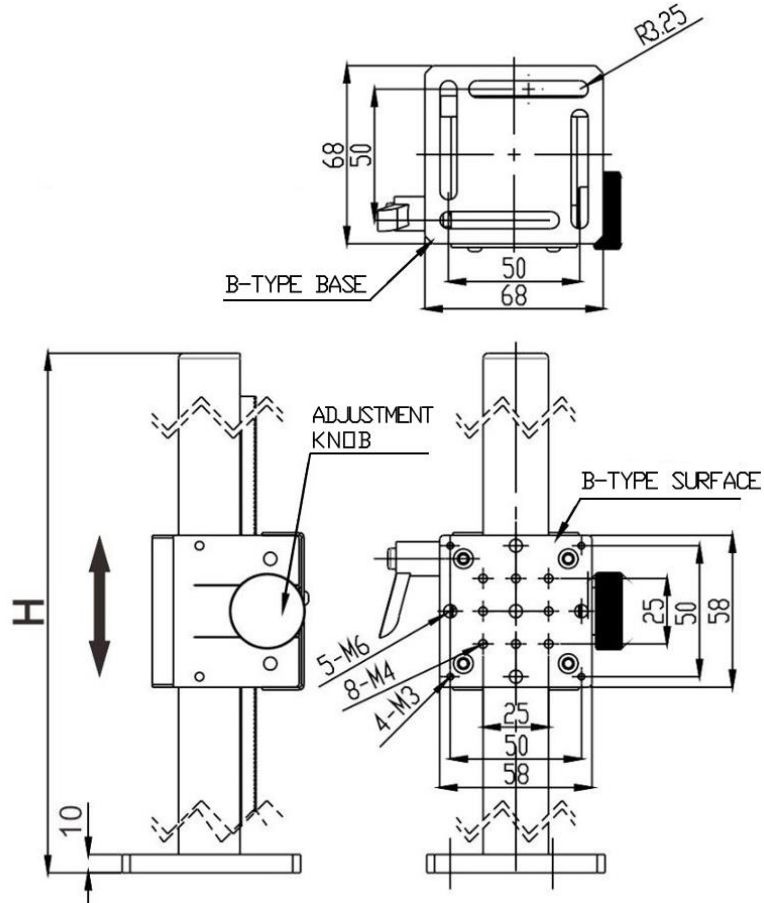

Technical Specifications:

Length (mm)	58 x 58
Height, H (mm)	300
Maximum Displacement (mm)	230
Weight (kg)	0.88

**NOTE: PROPRIETARY AND CONFIDENTIAL THE INFORMATION CONTAINED IN THIS DRAWING IS THE SOLE PROPERTY OF WAVELENGTH OPTO-ELECTRONIC(S) PTE LTD. ANY REPRODUCTION INPART OR AS A WHOLE WITHOUT THE WRITTEN PERMISSION OF WAVELENGTH OPTO-ELECTRONIC(S) PTE LTD. IS PROHIBITED.**