

Polarized Holder B-Series

Part Number: PHB-60

Mechanical Drawing:

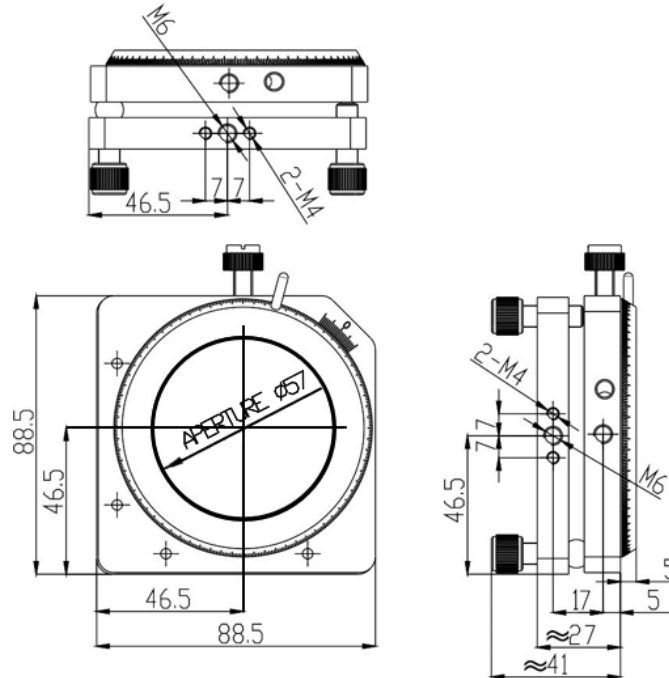

Technical Specifications:

Dimensions (mm)		88x88
Dimensions of Lens (mm)		Φ60x3~10
Polarization Range	Y-Axis	360°
	X and Z-Axis	±3°
Minimum Angle for X and Z-Axis		0.003°
Minimum Angle for Y-Axis		0.1°
Weight (kg)		0.28

NOTE: PROPRIETARY AND CONFIDENTIAL THE INFORMATION CONTAINED IN THIS DRAWING IS THE SOLE PROPERTY OF WAVELENGTH OPTO-ELECTRONIC(S) PTE LTD. ANY REPRODUCTION INPART OR AS A WHOLE WITHOUT THE WRITTEN PERMISSION OF WAVELENGTH OPTO-ELECTRONIC(S) PTE LTD. IS PROHIBITED.