

Polarized Holder B-Series

Part Number: PHB-40

Mechanical Drawing:

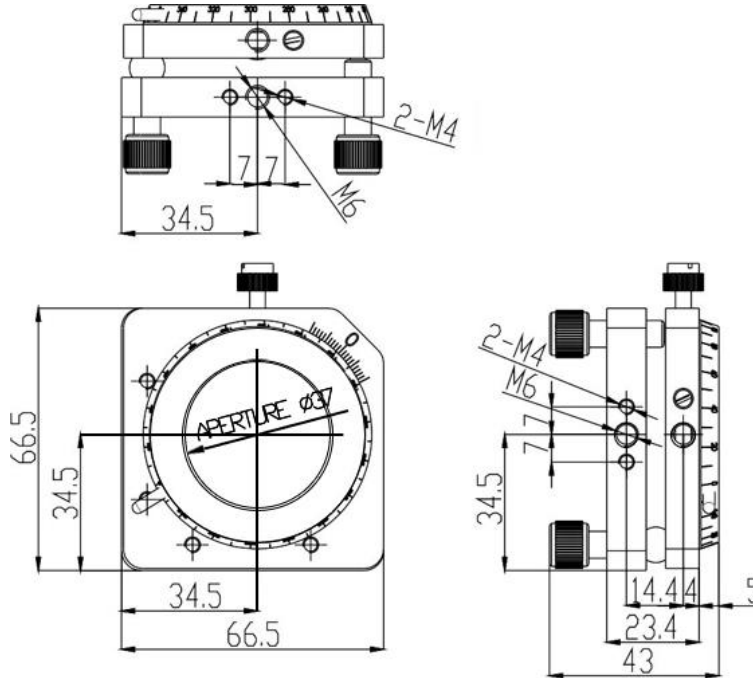

Technical Specifications:

Dimensions (mm)		66x66
Dimensions of Lens (mm)		Φ40x2~8
Polarization Range	Y-Axis	360°
	X and Z-Axis	±3°
Minimum Angle for X and Z-Axis		0.003°
Minimum Angle for Y-Axis		0.2°
Weight (kg)		0.15

NOTE: PROPRIETARY AND CONFIDENTIAL THE INFORMATION CONTAINED IN THIS DRAWING IS THE SOLE PROPERTY OF WAVELENGTH OPTO-ELECTRONIC(S) PTE LTD. ANY REPRODUCTION INPART OR AS A WHOLE WITHOUT THE WRITTEN PERMISSION OF WAVELENGTH OPTO-ELECTRONIC(S) PTE LTD. IS PROHIBITED.