

Polarized Holder A-Series

Part Number: PHA-50

Mechanical Drawing:

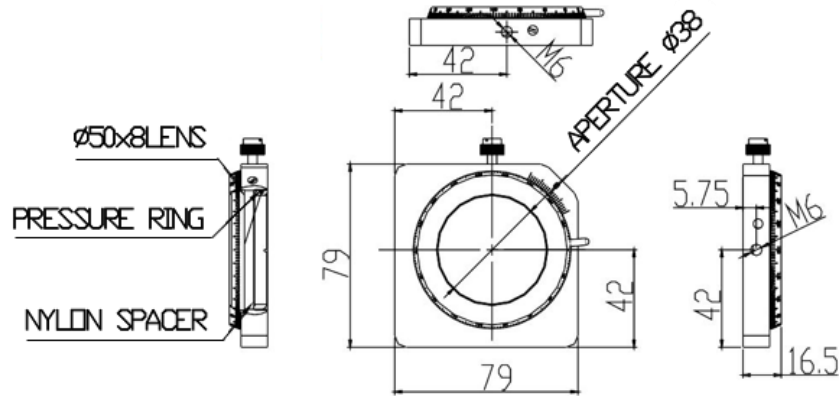

Technical Specifications:

Dimensions (mm)	79x79
Dimensions of Lens (mm)	Φ50x3~10
Polarization Range	360°
Minimum Angle	0.2°
Weight (kg)	0.16

NOTE: PROPRIETARY AND CONFIDENTIAL THE INFORMATION CONTAINED IN THIS DRAWING IS THE SOLE PROPERTY OF WAVELENGTH OPTO-ELECTRONIC(S) PTE LTD. ANY REPRODUCTION INPART OR AS A WHOLE WITHOUT THE WRITTEN PERMISSION OF WAVELENGTH OPTO-ELECTRONIC(S) PTE LTD. IS PROHIBITED.