

Optical Rail C-Series

Part Number: ORC-550

Mechanical Drawing:

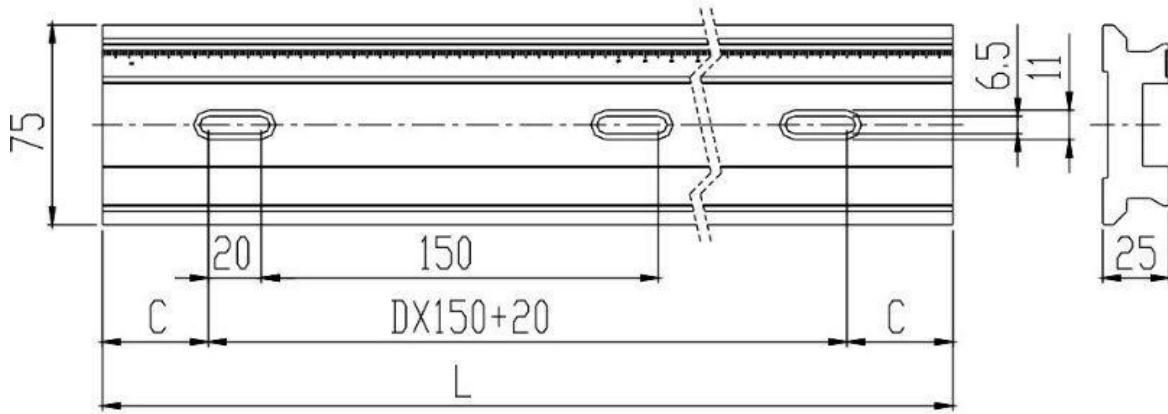

Technical Specifications:

Length, L (mm)	550
Height (mm)	25
Width (mm)	75
C (mm)	40
D	3
Optional Components	Carrier C

**NOTE: PROPRIETARY AND CONFIDENTIAL THE INFORMATION CONTAINED IN THIS DRAWING IS THE SOLE PROPERTY OF WAVELENGTH OPTO-ELECTRONIC(S) PTE LTD. ANY REPRODUCTION INPART OR AS A WHOLE WITHOUT THE WRITTEN PERMISSION OF WAVELENGTH OPTO-ELECTRONIC(S) PTE LTD. IS PROHIBITED.**