

Optical Rail B-Series

Part Number: ORB-500

Mechanical Drawing:

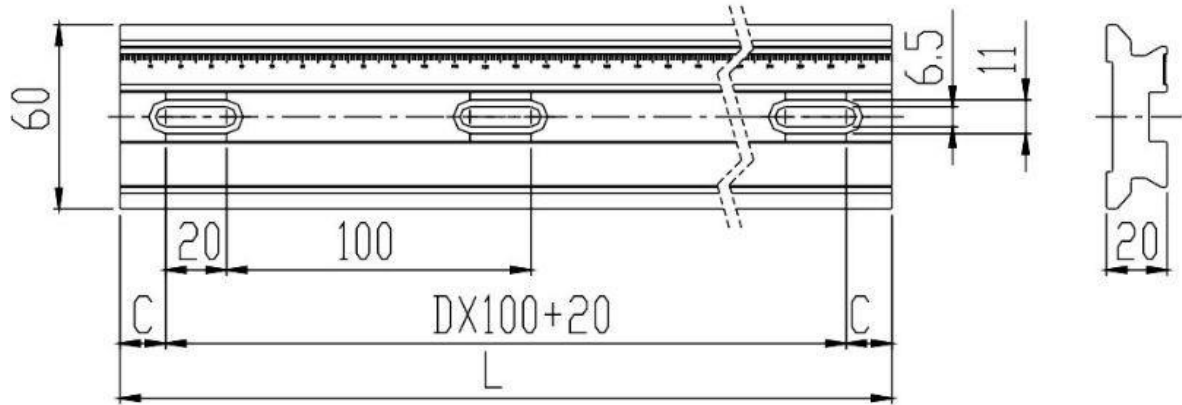

Technical Specifications:

Length, L (mm)	500
Height (mm)	20
Width (mm)	60
C (mm)	40
D	4
Optional Components	Carrier B

**NOTE: PROPRIETARY AND CONFIDENTIAL THE INFORMATION CONTAINED IN THIS DRAWING IS THE SOLE PROPERTY OF WAVELENGTH OPTO-ELECTRONIC(S) PTE LTD. ANY REPRODUCTION INPART OR AS A WHOLE WITHOUT THE WRITTEN PERMISSION OF WAVELENGTH OPTO-ELECTRONIC(S) PTE LTD. IS PROHIBITED.**